

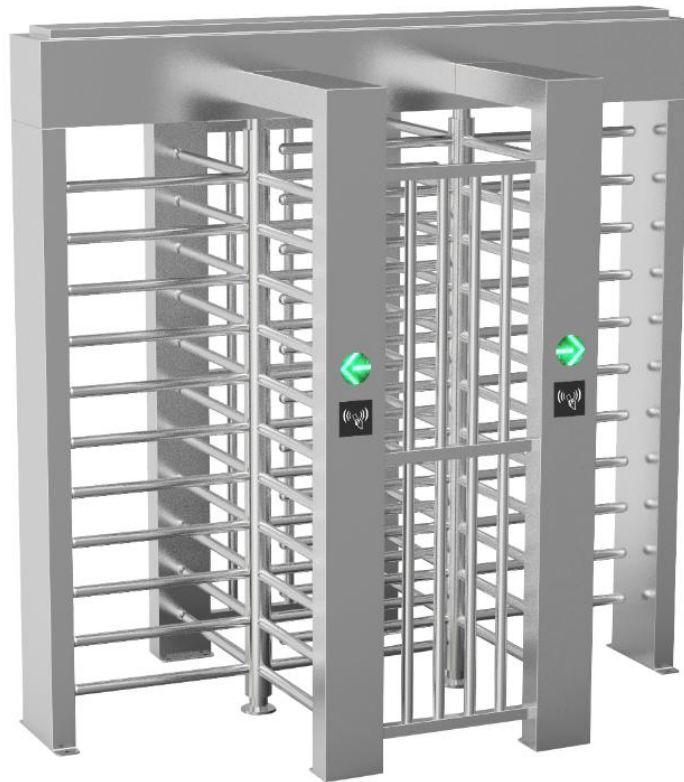

# Full Height Turnstile manual book



MODEL:  
**JS-QGZ006**

# Chapter 1 – Products specification

## 1.1 Products Introduction:

Full height turnstiles are floor-to-ceiling turnstiles with mechanical rotating barriers. They operate similarly to a revolving door with the only difference being that they allow access to one person at a time by locking after a single person makes entry into the system. Full height turnstiles are built to stop tailgating at the exterior of your facility. While they completely shut down any attempts at tailgating, they are not able to prevent piggybacking. Full height turnstiles are cost-effective and tend to have a lifespan of 25+ years.

We provide models in stainless-steel 304 and 316. They can be powder coated to your preference and can also be motorized. full waterproofed and weatherproofed

## 1.2 Dimension drawing

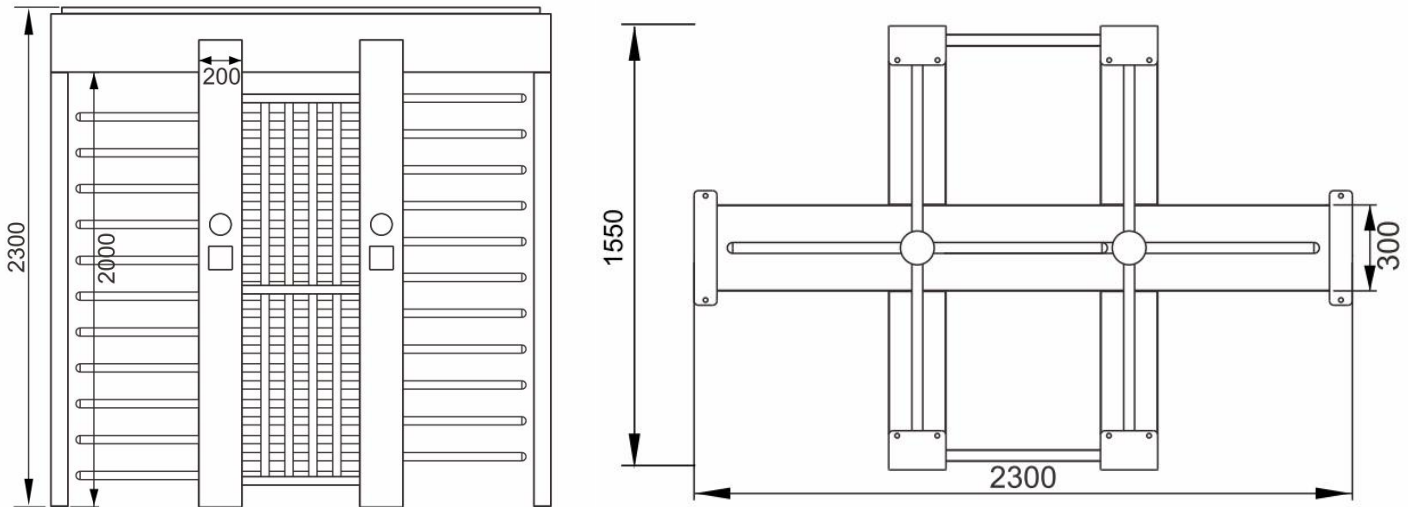

## 1.3 Product specifications

<b>Power Supply</b>	AC 220V/110V, 50/60Hz
<b>Operating Temperature</b>	-28 °C– 80 °C
<b>Operating Humidity</b>	5%–85%
<b>Working Environment</b>	Indoor / Outdoor both, IP54 Standard
<b>Rated Power</b>	60W
<b>Flow Rate</b>	25– 48 passage/minute
<b>Casework Material</b>	SUS304 (SUS 316 for option)
<b>Mechanism</b>	Semi automatic electromagnetic mechanism with hydraulic buffer function
<b>Control System</b>	Dry contact
<b>Emergency Alarm function</b>	Yes
<b>Dimension</b>	2300*1550*2300MM

<b>Net Weight</b>	280kgs
<b>Material Thickness</b>	1.5mm
<b>MCBF</b>	Electromagnetic mechanism 5 million cycles
<b>Warranty</b>	2 years

## Chapter 2 – INSTALLATION

Installation Guidance :

Please make sure at lease two people make Installation

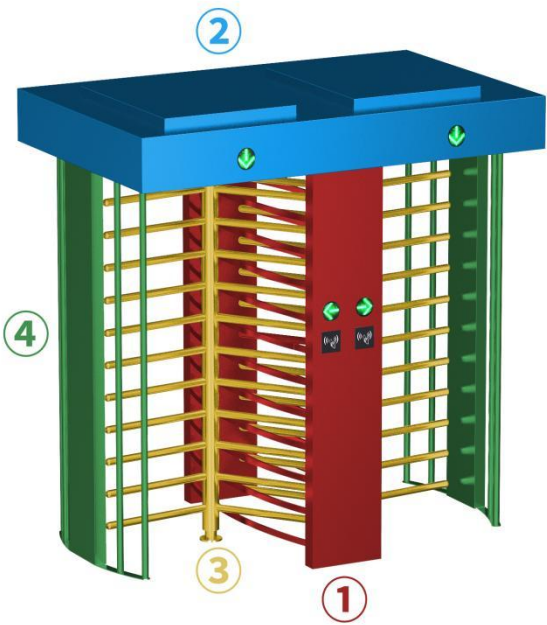

STEP:

1. Push the middle part to the installation position first,
2. Lift the full-height top up, open the top cover you can find 4 nuts inside, you can adjust the angle of the middle part, let the 4 nuts fit in the middle column
3. Then installed the 120 degree rotate inside, fix it on the top, and vertically to the ground
4. At last Install the side guardrail , and there are nuts on the top to fix it

**Note:** The above steps are to determine the position of the expansion screw

After everything is installed, mark the position of the expansion screw on the ground, (the middle access control part needs to open the maintenance window to see the position of the expansion screw,)

Then take the gate apart again

Put expansion screws on the marked position on the ground, and then install the full-height gate back according to the steps as above again

5. After all well installation , fix the turnstile with Expansion screws

### Cable connecting

Control system

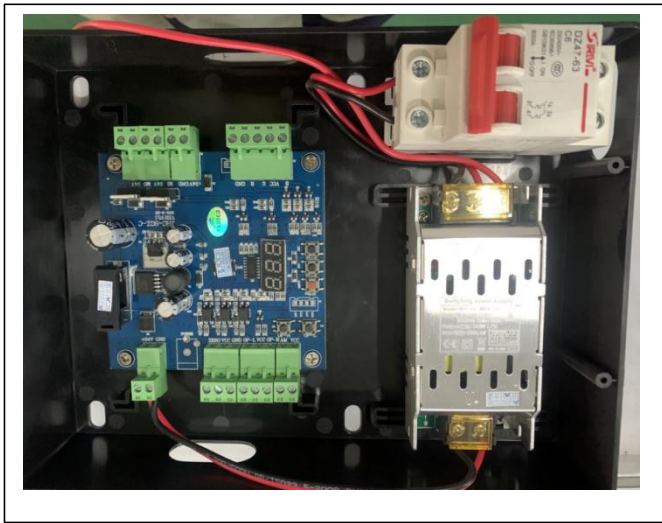

electromagnetic motor with buffer function

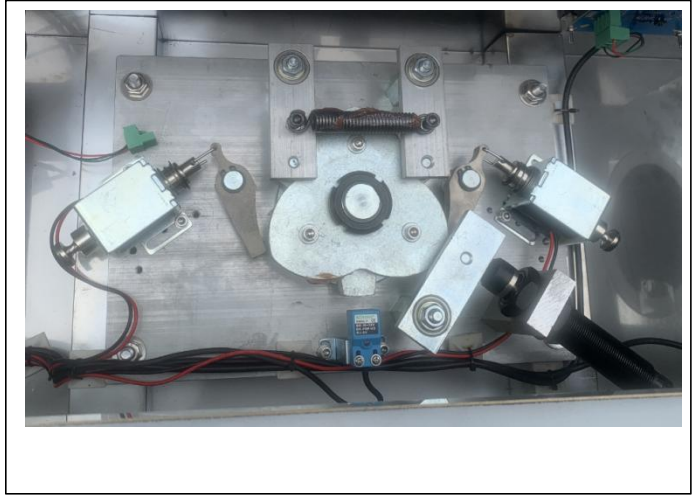

7. Your access control system connected with relay signal



220V power to air switch , either port is ok



## *Chapter 3 – Main board setting*

# **Mainboard Parameter description**

Suitable for tripod turnstile/waist height/full height turnstile

**1: Switching power supply wiring diagram**

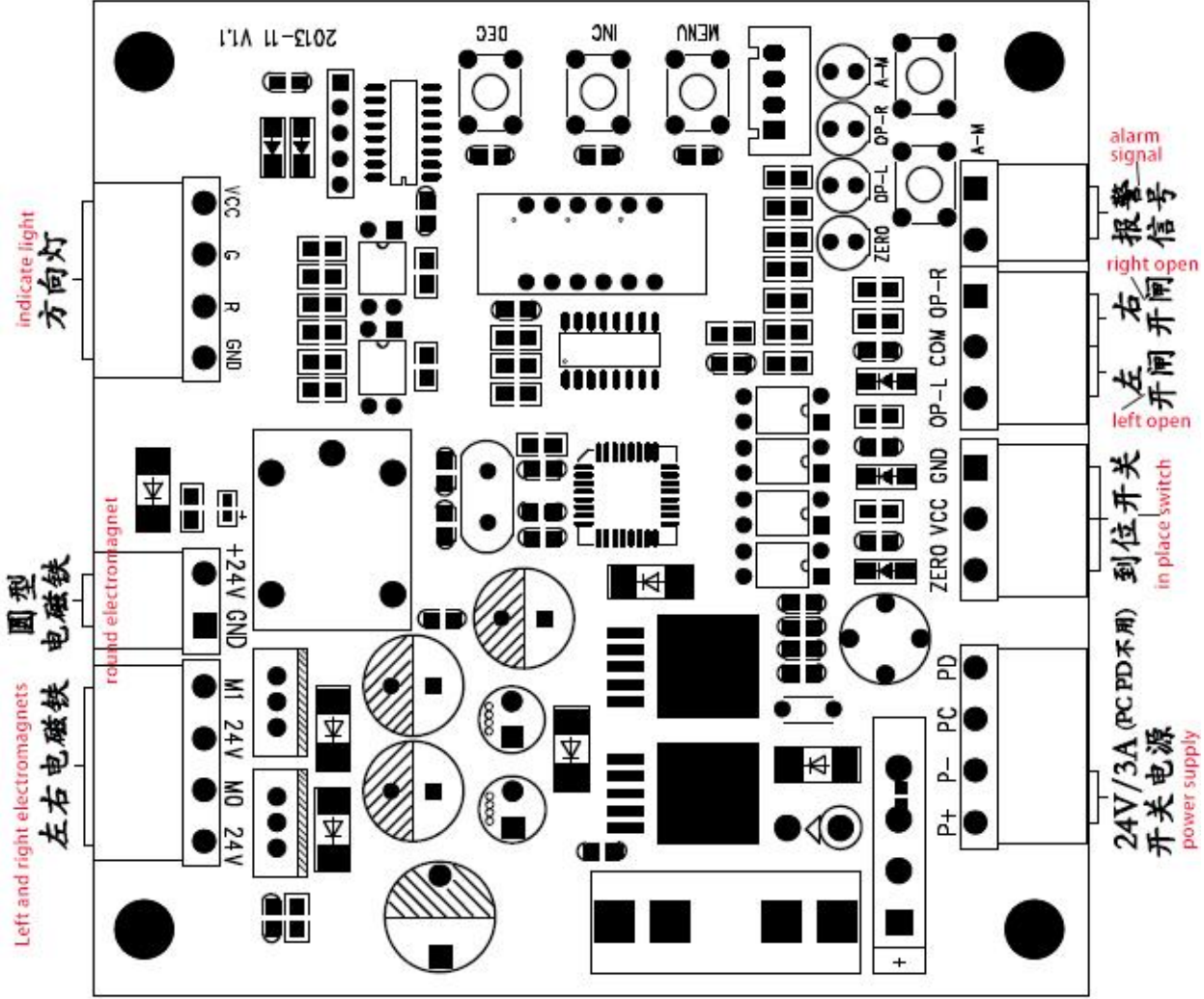

## 2: Transformer wiring diagram

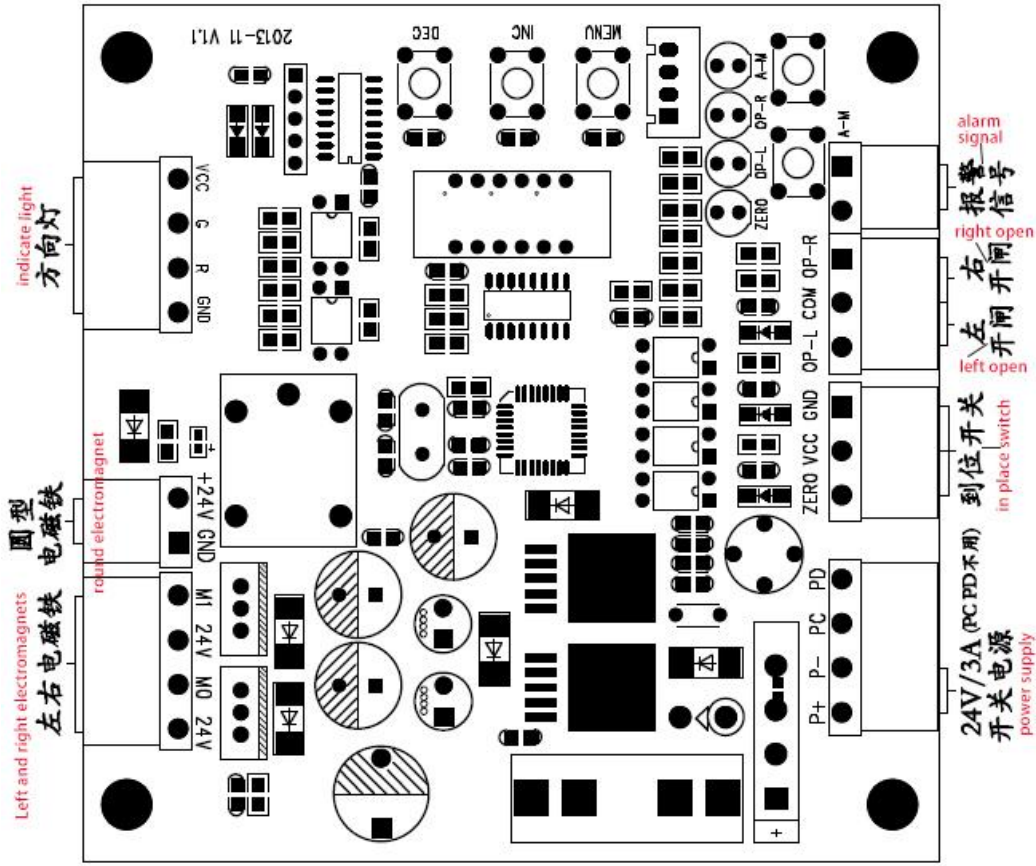

### Menu setting description

Control panel keys: "MENU" menu key, "INC" up/up key, "DEC" down/down key three operation keys.

Function description of each function key:

"MENU" key: 1: Long press this key in the standby interface to enter the system menu: 2: In the system menu interface, select the corresponding menu and press this key to enter the menu parameter setting interface: 3: Press this after the menu is set key to save the parameters and return to the system menu interface.

"INC" key: turn up to select the system menu and the function of +1 when setting parameters

"DEC" key: scroll down to select the system menu and the function of -1 when setting parameters

**NOTE:** In the system menu and menu setting interface, if there is no key operation within 5 seconds, the system will automatically exit the menu to the standby interface.

For example, to change the access duration of the gate passage :

Step 1: Long press the "MENU" key to enter the system menu, and use the "INC" and "DEC" keys to scroll up and

down respectively to select the " **F01** " menu ( see the [menu description below](#) ).

Step 2: Press the " **MENU** " key to enter the channel duration setting interface.

Step 3: Use the " **INC** " and " **DEC** " keys to add and subtract parameter values up and down respectively.

Step 4: After the setting is completed, press the " **MENU** " key to save.

Step 5: Exit the menu: flip the menu to the " **F 10** " menu, press the " **MENU** " key to exit the menu manually or automatically exit the menu if you do not operate the key for 5 seconds.

### Three-stick board parameter setting description:

< Run > is displayed on the LED screen .

#### A. System menu description:

1. " **F01** ":

Set the passage duration of the channel. Within the set time, the time will be automatically cleared after the person passes the gate. If no one passes, the gate will automatically close when the time is up. ( [The system defaults to 5 seconds](#) )

2. " **F02** "

Normally open function setting. 1: When normally open, only the left electromagnet is turned on. 2: When normally open, only the right electromagnet is turned on. 3: Open the left and right electromagnets when normally open. ( [The default value is 3, when it is normally open, the electromagnets on both sides are turned on](#) )

3. " **F03** "

Gate operating mode. 0: Free passage (commonly used on turnstiles) 1: Power-off drop bar ( [default 1 power-off drop bar](#) )

4. " **F04** "

memory function. Whether there is a memory function when opening or closing the entrance and exit, it is generally used for swiping a card to open the gate, whether to remember the card swiping situation of other people when one person has not passed the card swiping. "Prohibited" [means that after the first person swiping the card is passed](#) , the second person swiping the card will be valid; "Allow" means that the number of people who swipe the card is how many consecutive people are allowed to pass. ( [default value 0, disable memory](#) )

5. " **F05** "

Repeated opening and closing test is mainly used to test the stability and aging test of the gate control board.

Note : In test mode, press **MENU** key to exit the test

6. " **F06** "



Zero signal setting. 0: Close the gate immediately when the zero signal is detected (standard mode of the three-roller gate, the default setting of the main board is 0); 1: Detect the zero signal, and then wait for the zero signal to disappear before closing the gate ( [commonly used on the full height](#) ) ( [default value 0](#) )

7. " **F07** "

The gate normally open setting, the unit is seconds. This parameter is used to detect the continuous opening signal. When the duration of the continuous opening signal exceeds the set parameter, the system enters the normally open state ( [which side of the electromagnet is normally open is determined by the F02 parameter, and the F02 parameter defaults to the two sides of the normally open electromagnet.](#) ). If the opening signal to the turnstile is a continuous signal, the turnstile will always be in the open state. After the continuous signal is disconnected, the turnstile will return to the standard mode. ( [The default parameter is 0 seconds, normally open and closed](#) )

8. " **F08** "

Opening delay. This parameter is only valid when the memory function is turned on. After the memory function is turned on, the opening delay is when there are too many people in a row. This function can prevent the gate from opening again when the previous person has not passed the channel. ( [default value 0, no delay](#) )

9. " **F09** "

reset. All parameters of the motherboard are restored to factory settings.

10. " **F10** "

Exit the menu. Or automatically exit if there is no key operation within 5S

## type C control board parameter description V 2.0

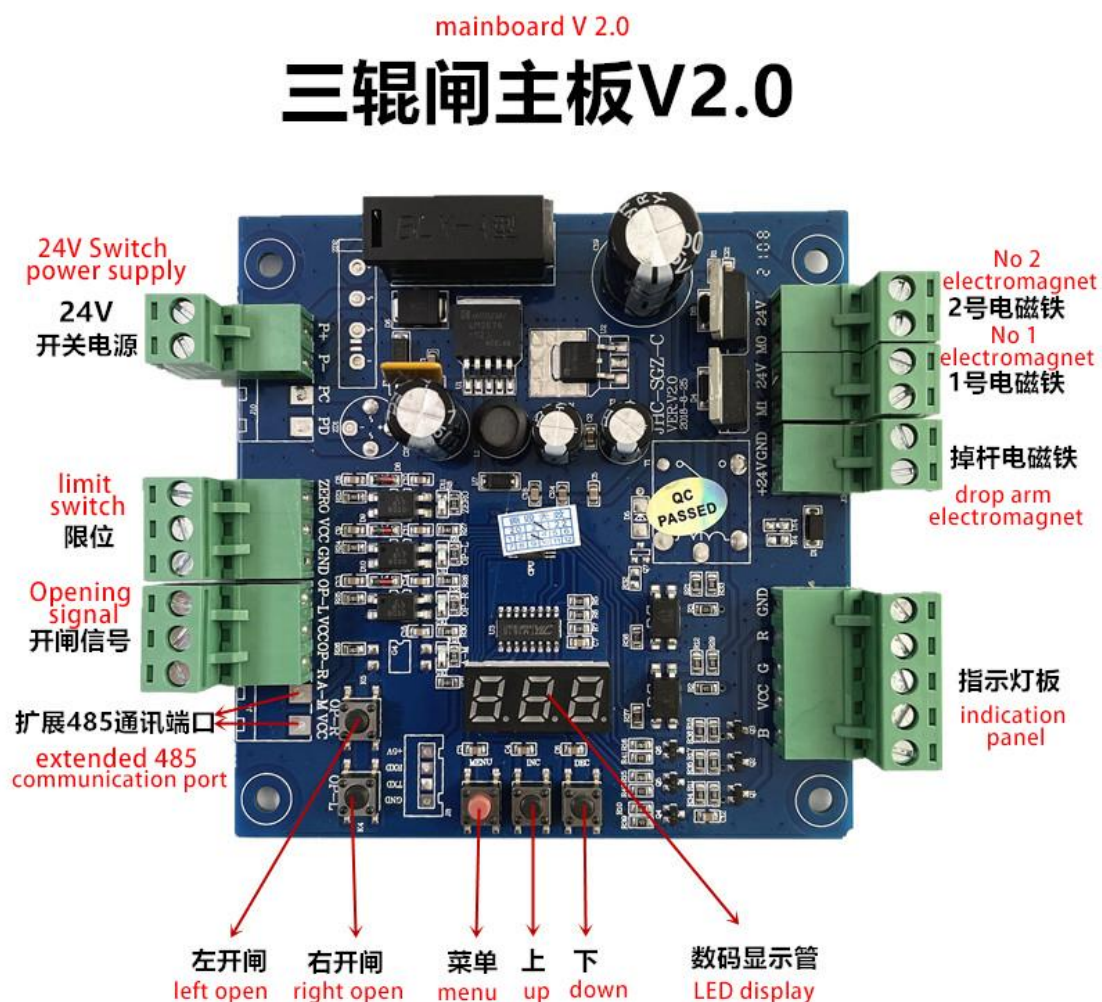

### Menu setting description

Control panel keys: " **MENU** " menu key, " **INC** " up/up key, " **DEC** " down/down key three operation keys.

Function description of each function key:

" **MENU** " key: 1: Long press this key in the standby interface to enter the system menu: 2: In the system menu interface, select the corresponding menu and press this key to enter the menu parameter setting interface: 3: Press this after the menu is set key to save the parameters and return to the system menu interface.

" **INC** " key: turn up to select the system menu and the function of +1 when setting parameters

" **DEC** " key: scroll down to select the system menu and the function of -1 when setting parameters

**NOTE:** In the system menu and menu setting interface, if there is no key operation within 5 seconds, the system will automatically exit the menu to the standby interface.

For example, to change the access duration of the gate passage :

Step 1: **Long press the " MENU " key** to enter the system menu, and use the " **INC** " and " **DEC** " keys to scroll up and down respectively to select the " **F01** " menu ( see the **menu description below** ).

Step 2: Press the " **MENU** " key to enter the channel duration setting interface.

Step 3: Use the " **INC** " and " **DEC** " keys to add and subtract parameter values up and down respectively.

Step 4: After the setting is completed, press the " **MENU** " key to save.

## parameter setting description:

Function	menu	set range	Defaults	Parameter Description
Set the passage time	F01	240	5	Within the set time, the time will be automatically cleared after the person passes the gate. If no one passes, the gate will automatically close when the time is up. ( <b>The system defaults to 5 seconds</b> )
Allow and forbid passage	F02	0/1 /2 /3	1	0: All left and right openings are prohibited. 1: All are allowed. 2: Left opening is prohibited, right opening is allowed. 3: Right opening is prohibited, left opening is allowed. ( <b>All are allowed by default</b> )
Gate operating mode	F03	0/1	1	0: Free passage (commonly used on turnstiles) 1: Power-off drop bar ( <b>default power-off drop bar</b> )

memory function	F04	0/1	0	Whether there is a memory function when opening or closing the entrance and exit, it is generally used for swiping a card to open the gate, whether to remember the card swiping situation of other people when one person has not passed the card swiping. "Prohibited" means that after the first person swiping the card is passed , the second person swiping the card will be valid; "Allow" means that the number of people who swipe the card is how many consecutive people are allowed to pass. ( disabled by default )
Repeated opening and closing test	F05			Mainly used to test the stability and aging test of the gate control board. C-5 : In test mode, press <b>MENU</b> key to exit the test
Zero work setting	F06	0/1	0	0: Standard mode, 1: Reset mode after the zero signal is disconnected. ( The motherboard defaults to 0 );
Proximity switch count reset setting	F07	1-30	1	The default setting of the motherboard is 1 , and it will sense a reset , and so on.

Always open setting	F08	0-20	5	"Gate normally open setting" This parameter is used to set the number of S when the gate opening signal exceeds, the system will enter the normally open state. , If the opening signal to the turnstile is a continuous signal, the turnstile will always be in the open state. (The motherboard defaults to 5 seconds)
485 Xun Xun IP address settings	F09	1-99	1	The motherboard defaults to an IP address of 0 1 . For example, there are two machines that need the computer to send action commands. In order not to interfere with each other, the other machine can be set to the IP address of 02.
reset	F10			All parameters of the motherboard are restored to factory settings. Display --- then press MENU to confirm and exit.

#### RS485 communication protocol

Baud rate: 96 00 parity bit N, data bit 8, stop bit 1

The factory default of the communication address bit is 01

Factory default:

AA 55 01 (communication address bits can be set) F3 01 is left open

AA 55 01 (communication address bit can be set) F3 0 5 is stop

AA 55 01 (communication address bit can be set) F3 0 3 is the right opening

AA 55 01 (communication address bit can be set) F3 0 7 is the fire signal opening

AA 55 01 (communication address bit can be set) F3 0 A is the host reset

To operate the left open gate, send the command: AA 55 01 F3 01

## ***Chapter 4 – Safety attentions***

- Do not strike the product with hard objects.
- Handle carefully when using to avoid strong collision with hard objects.
- The product must not be exposed to water or corrosive liquids.
- If smoke or odor is found in the product, disconnect the power immediately.
- If the product is abnormal, please contact the dealer in time. Do not attempt to repair it by yourself. If you do not contact the dealer, handle it without permission, and the company will not be responsible for any damage.

## ***Chapter 5 – Transportation and storage***

- Handle the product with care when handling it.
- During the transportation and storage of the product, care should be taken in a dry and free of corrosive or explosive gas in the surrounding air, and measures should be taken to prevent moisture, rain, sun, and corrosion

Thank you for your support, we are very happy to be your partner and provide you with our services. If you encounter any problems during the installation, you can contact your service manager at any time. We will serve you wholeheartedly ,ENJOY!

----- KARSUN TEAM