

## Flap Turnstile

Model No:JS-Y010



### Products Introduction:

JS-Y010 Series Flap Turnstiles are robust products functioning to provide pedestrian access control in areas requiring moderate level of security. With its compact case design, provides a perfect solution for tight installation areas. Encoder and PLC controlled obstacle movement is provided by brushless DC motor, and enhanced with security features such as anti-tail-gating and anti-pass-back, with five pairs of optical sensors embedded in the turnstile case, which in total ensures one of the highest reliability available in market and a remarkably long life even in case of intensive usages.

JS-Y008 Series flap Gates are the perfect solution, where design, aesthetics and passage speed are important.

### Application Location:

Using flap turnstiles is a popular choice for bus station, school, factory entrance and exit management. They eliminate the need for attendants at entrances and provide a means to count the number of pedestrians entering into a facility. These turnstiles paired with card readers and electronic operation are the most popular choice for subway systems and can be found in most of them.

### Access Control System (Optional)



**SWIPE CARD**  
Access with authorized card and payment card sex piece swipe to open the way



**IRIS RECOGNITION**  
Use the authorized eyes of Iris Recognition to pass through the entry gates



**FINGERPRINT RECOGNITION**  
Access with authorized fingerprint authentication



**PALM VEIN RECOGNITION**  
Use authorized palm vein recognition to pass into



**COIN/TICKET**  
Use disposable coins to coin through to enter



**FACE RECOGNITION**  
Use authorized face recognition to enter



**QR CODE**  
Scan in with authorization QR code and barcode



**MANUAL OPERATION**  
Manual use of wired and wireless to open gates for entry

# Features



## Reliability

- Alloy steel flap hub prevents mechanical wear
- Casework and flap arms manufactured in SUS304 stainless steel
- Electromagnets for lock are used only when being activated. They are in standby mode when the device is idle.
- KARSUN compact mechanism ensures the long life of the lubricating oil inside.
- High quality electrical components



## Safety and User-Orientated Design

- The arm designed for emergency purpose
- No exposed screws, safer for the user.
- Smooth operation designed for mass transit application
- The pictogram on the device indicating access permission and direction of movement
- Special designed case shape, user-friendly for passenger to punch card or finger.

## Easy Integration

- Flexible reader installation plate. Customers can easily integrate with third party reader
- Standard electrical interface for third party device.
- By using compact mechanism, the turnstile has more space inside for integration
- KARSUN provides integration service in factory, with board and peripherals installed, ensuring compliance of the system. When the turnstile is delivered, just plug it in and do the setting. Save the cost of installation.



# Specifications

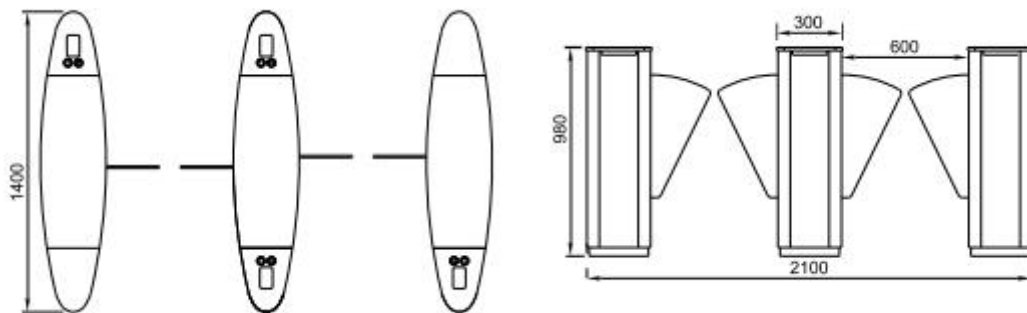

<b>Brand name</b>	<b>KARSUN</b>
Motor type	DC brushless motor
Flow rate	40-60people/minute
Passage width(mm)	≤600
Rated Power	50W
Cabint material	SUS 304;1.5mm top lid/1.2mm side
Infrared sensor	3 pairs
Input/Output signal	dry contact/relay signal
Dimension	1400*300*980mm
Net weight	55KG
Gross weight	57KG
IP	IP44
Operating Temperature	-10 °C- 60 °C
Operating Humidity	5%-85%
Working Environment	Indoor/Outdoor covered
Voice prompt	Yes