

Swing Turnstile

Model No:JS-XBZ020

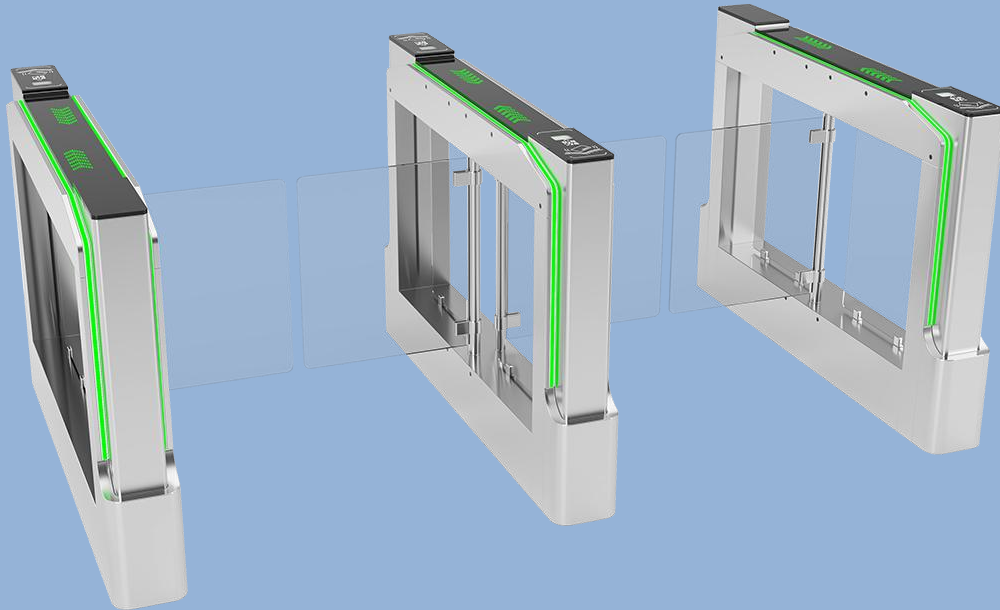









Products Introduction:

The JS-XBZ020 Swing gates are stylish waist-high security speed gates that operate on the swing open principle with stainless (or acrylic) panels acting as the barrier gate. Depending on which side of the Karsun Swing Lane the person approaches, the gate when authorised, will swing open in the opposing direction allowing them passage through the controlled lane. The Karsun Swing Lane has the ability to embed most manufacturers access control readers beneath its top glass cover, and with the intuitive LED user indication and guidance, this security speed gate encompasses safety with high traffic flow capacity. The Karsun Swing Lane is offered with different dimensions of swinging gates, which enables lane widths of up to 1000mm.

Application Location:

Using swing turnstiles is a popular choice for any sites where requires wide passage (for people carrying large parcels, or the disabled) strict pedestrian access control (anti-following) and fast accessing rate(at 40-45persons/minute), for example, station, hotels, banks, clubs, office buildings, gyms.They eliminate the need for attendants at entrances and provide a means to count the number of pedestrians entering into a facility. These turnstiles paired with card readers and electronic operation are the most popular choice for entrance and exit systems and can be found in most of them.

Access Control System (Optional)

- | | | | |
|---|--|---|---|
|  <p>SWIPE CARD
Access with authorized card and payment card sex piece swipe to open the way</p> |  <p>IRIS RECOGNITION
Use the authorized eyes of Iris Recognition to pass through the entry gates</p> |  <p>FINGERPRINT RECOGNITION
Access with authorized fingerprint authentication</p> |  <p>PALM VEIN RECOGNITION
Use authorized palm vein recognition to pass into</p> |
|  <p>COIN/TICKET
Use disposable coins to coin through to enter</p> |  <p>FACE RECOGNITION
Use authorized face recognition to enter</p> |  <p>QR CODE
Scan in with authorization QR code and barcode</p> |  <p>MANUAL OPERATION
Manual use of wired and wireless to open gates for entry</p> |

Features



Reliability

- Alloy steel swing hub prevents mechanical wear
- Casework and swing arms manufactured in SUS304 stainless steel
- Electromagnets for lock are used only when being activated. They are in standby mode when the device is idle.
- KARSUN compact mechanism ensures the long life of the lubricating oil inside.
- High quality electrical components



Safety and User-Orientated Design

- Drop arm designed for emergency purpose
- No exposed screws, safer for the user.
- Smooth operation designed for mass application
- The pictogram on the device indicating access permission and direction of movement
- Special designed case shape, user-friendly for passenger to punch card or finger.
- Anti-tailgate



Easy Integration

- Flexible reader installation plate. Customers can easily integrate with third party reader
- Standard electrical interface for third party device.
- By using compact mechanism, the turnstile has more space inside for integration

- KARSUN provides integration service in factory, with board and peripherals installed, ensuring compliance of the system. When the turnstile is delivered, just plug it in and do the setting. Save the cost of installation.



Specifications

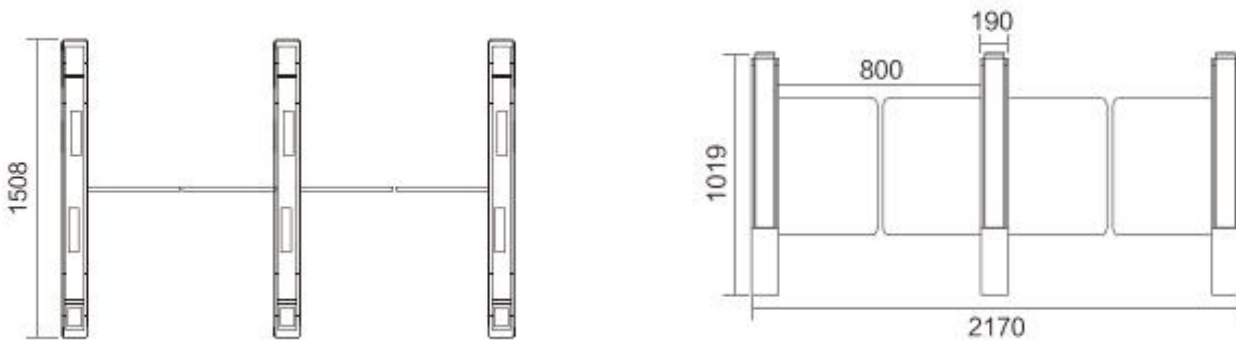

Brand name	KARSUN
Motor type	DC brushless motor
Flow rate	40-50people/minute
Passage width(mm)	≤1000
Rated Power	50W
Cabint material	SUS 304;1.5mm top lid/1.2mm side
Infrared sensor	4 pairs
Input/Output signal	dry contact/relay signal
Dimension	1508*190*1019 mm
Net weight	55KG
Gross weight	57KG
IP	IP44
Operating Temperature	-10 °C- 60 °C
Operating Humidity	5%-85%
Working Environment	Indoor/Outdoor covered
Voice prompt	Yes