



Flap Turnstile manual book



MODEL:
JS-Y020

Dimension drawing

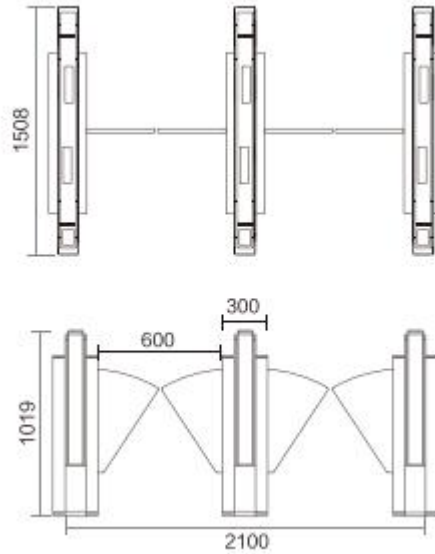

Chapter 1 – Products specification

1.1. Product specifications

The **JS-Y020** flap turnstiles have the following characteristics:

- Power requirements: 110V -220V, 250W to 500W. The swing turnstiles are provided with different power supplies, based on country and customer's requirements. Check the product label before connecting to any power supply.
- Driver motor: 24Vdc, max. 40W
- Output interface: 12Vdc
- Communication interface: Relay, (RS232, RS485 for option, can be customize)
- Operating temperature: 14°F to 122°F [-10°C to 50°C]
- Operating humidity: 20% to 95% RH non-condensing

Chapter 2 – INSTALLATION

Before proceeding to the installation of the turnstile, unpack all components and check to make sure the all parts from the packing slip are included, verify dimensions and conduit runs.

Use the turnstile template to properly align and lay out the site and to determine the right location of the floor stub-ups and anchors.

Site preparation:

- Make sure that the floor is level before the installation process starts.
- When measuring the distance between the cabinets always refer to the center of the cabinets, not the corners.
- Using the factory provided template and design layout drawings outline the exact position of each turnstile. Make sure the floor outline includes the space dedicated to conduit stub-ups.
- Install conduits for low voltage cables and for 110Vac (220Vac) power. Size conduits based on the number of cables and follow local installation codes.
- Install one ¾ inch conduit for turnstile communication between two cabinets that form one lane.
- Depending on the position, each enclosure can host one or two motors. The end cabinets have only one motor (SM series) and the middle cabinets have two motors (DM series).
- Each controller operates one motor. SM series have one controller and DM series have two controllers.
- On the turnstile floor footprint, locate anchoring holes. Drill and install foundation screw bolts or M12 anchor bolts.
- Align and install the turnstile cabinet on the anchor bolts. Secure the cabinet to the bolts.
- Follow wiring diagram to terminate the cables on the turnstile control panel. The following connections are required:
 - o Card reader to control panel reader port. The control panel can be located inside the turnstile or outside.
 - o Communication cable between cabinets.
 - o Lane OPEN command from the turnstile to the access control panel door open relay.
 - o If required, an emergency open button or switch can be wired to the turnstile controller board.
 - o 110Vac (220Vac) is required for each turnstile cabinet.
- For physical installation setup refer to the next drawing.

Installation Design

- ◆ Place the turnstiles in the correct direction and combination.
- ◆ After connecting the power and testing the basic functions are normal, turn off the power and place the turnstile in the entrance where it needs to be installed.
- ◆ Mark the drilling position, punch hole to fix the gate.
- ◆ After set holes, drilled holes, and embedded M12 anchor bolts or expansion bolts.

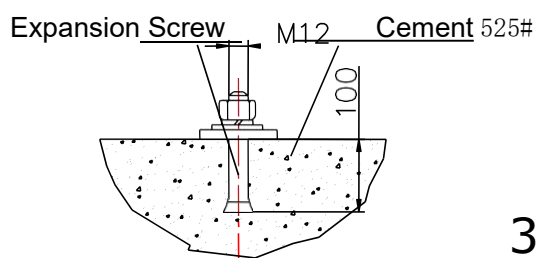



Warning

1. The depth of buried PVC pipes should be greater than 60mm, and the height of exposed ground should be greater than 50mm. And the outlet is bent back to prevent water from entering the line pipe
2. When installing access gates, the left and right gates of each channel should be aligned;
3. Connect the system protection ground wire;
4. If the equipment is used outdoors, a 100~200mm high cement level should be built at the equipment installation place. Tailai to isolate moisture, and add sunscreen and rainproof facilities such as roof;
5. After the equipment is installed, the state inspection and functional debugging are qualified before it can be put into normal use.

Chapter 3 – cable connecting

3.1 synchronous line connection direction

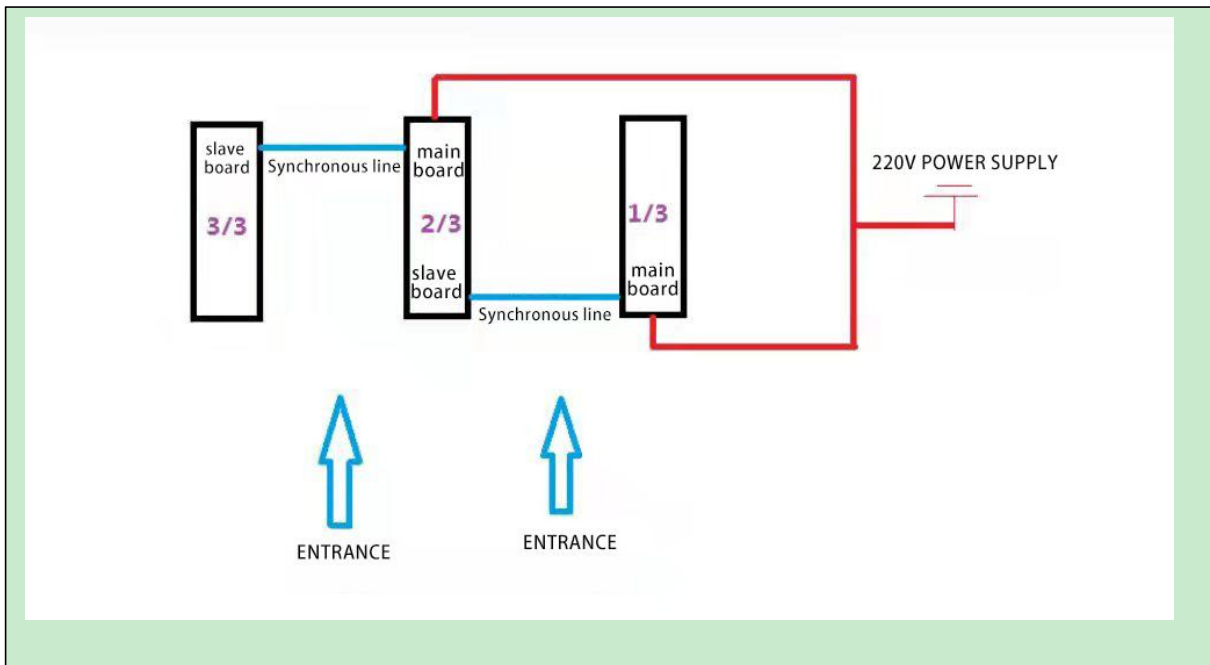

3.2 Control box

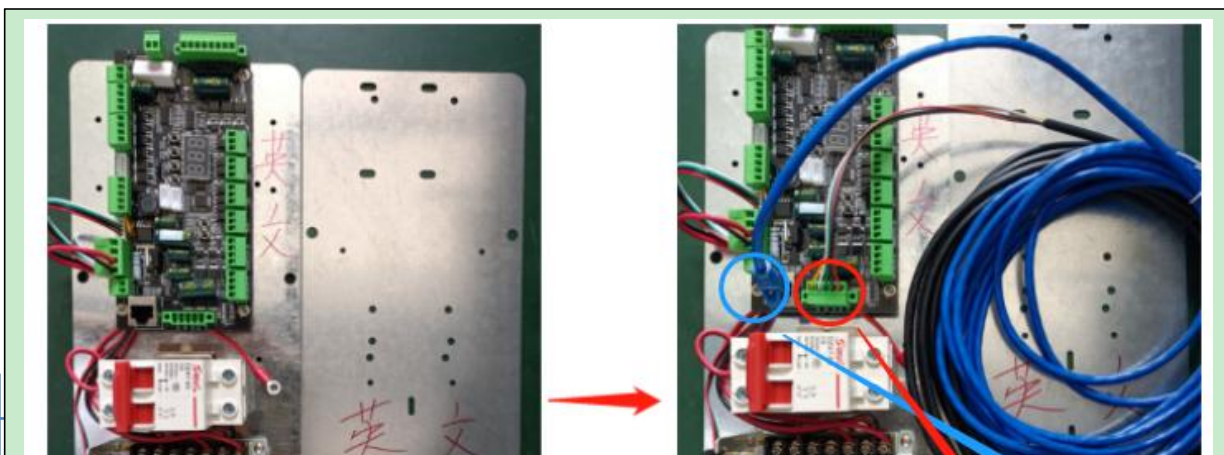

3.3 Cable connecting

Please pay attention that these sync cable color should match each other like bellow photo

Step :

1. connected sync cable main board to slave board as bellow
2. connected internet cable to main board and slave board as bellow (internet cable between main board and slave board for sync the infrared sensor)
3. connected 220V power to air switch as bellow (two port, either is ok)
4. should you use your own access control system could connected your access control board to relay port (OPEN L and OPEN R)

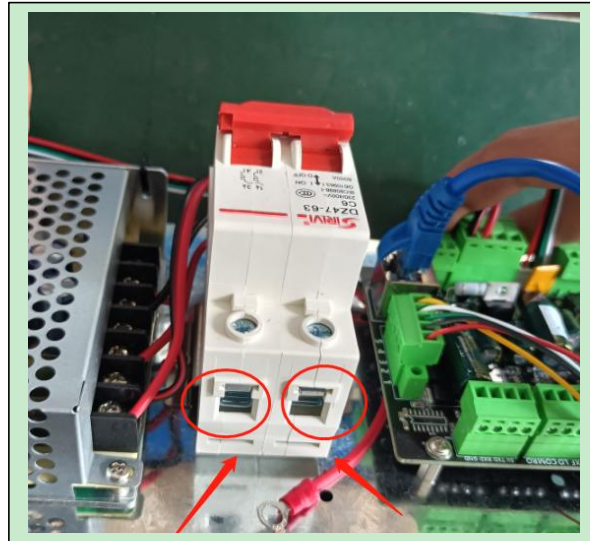
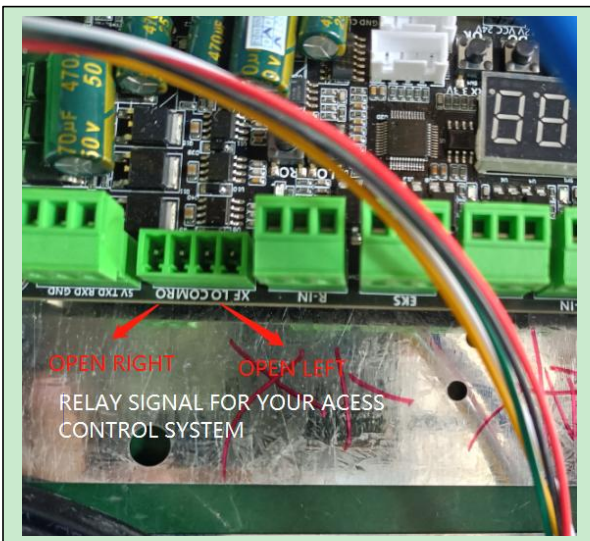

Chapter 4 – Main-board Features

This control board is suitable for the control of wing gates, swing gates and quick-pass gates equipped with DC brushless motors.

1. This control board adopts ARM embedded system as the core of control. It has the advantages of faster processing speed, more powerful function expansion and more stable performance.
2. Adopt full data management, all function parameters are set digitally, setting operation is simpler.
3. The motor drive runs according to the movement curve, the operation is stable and reliable, the state is smooth, and the brake movement is coordinated and synchronized.
5. The equipment is fully functional, with an illegal break-in alarm, a trailing alarm, a reverse processing, an anti-pinch on the ram, and a free passage setting
6. Single or multiple people, motor stall protection, delay of exit passage, peak traffic mode, emergency traffic mode and other functions.
7. Complete interface mode, both PNP and NPN infrared beams on the market can be used. The infrared sensing sequence can be set up and down.
8. Customer-defined indicator output mode. The side lights and ceiling lights can be set according to the needs of the device to display the status of the lamp and the common cathode and common anode of the lamp.
9. The control panel comes with a voice broadcast function, and the directions of the greeting language at the entrance and exit can be set in the menu.

Technical Parameters

Input power: 24V/3A Drive

Motor: 24V/20W

Infrared sensor interface: NPN normally open collector open circuit Communication

interface: RS232 serial port

Communication distance: ≤10 meter

Input interface: 12V level signal or 12V pulse signal with pulse width >100ms, drive current >10mA

Output power: DC 12V ≤1A

relative humidity: 0-90% (No condensation)

environment temperature: -15C-60C

Passing speed: 35 people/min (normally open mode), 25 people/min (normally closed mode) Gate opening and closing time: 0.8 seconds for flap gates; 1-2 seconds for swing gates.

Chapter 5

5.1 Main board wiring diagram

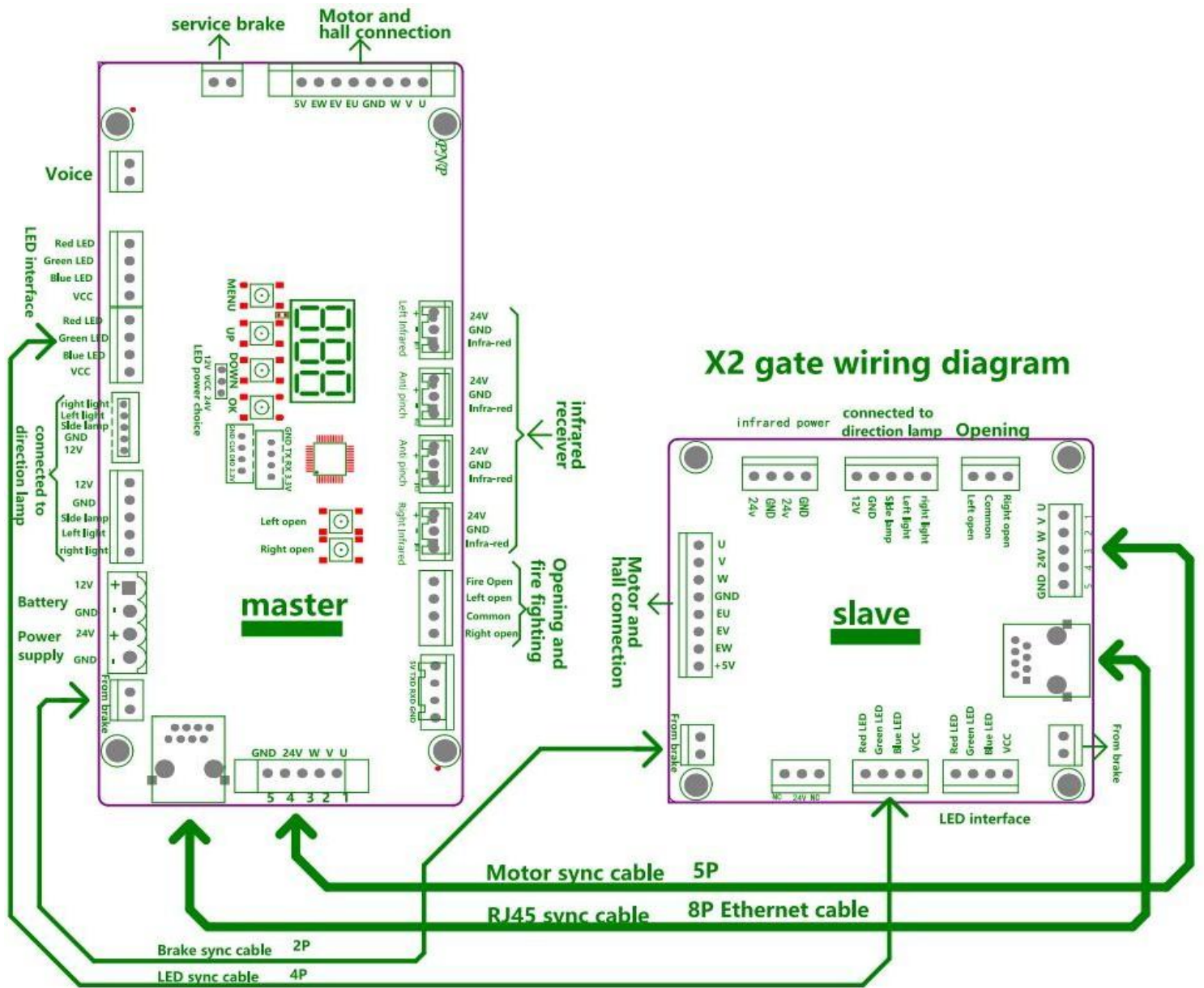

5.2 Main-board parameter setting operation flow

1. operating procedures:

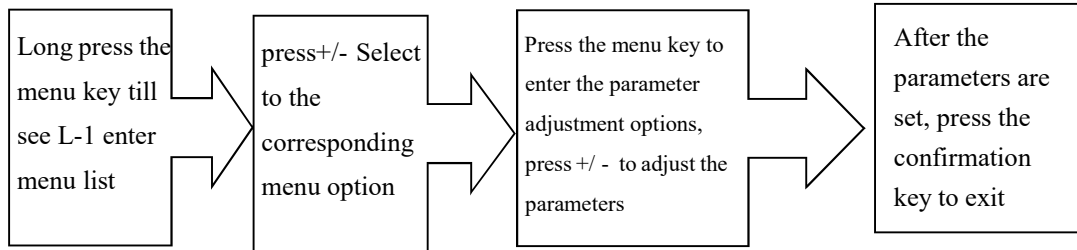

2. Digital tube display:

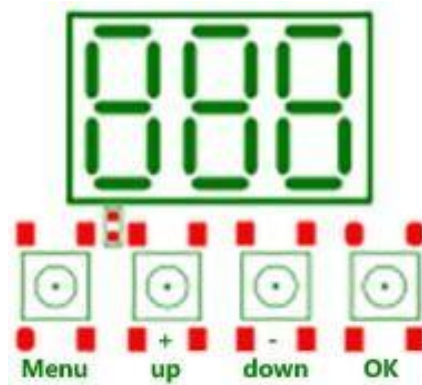

5.3 Parameter setting table

Menu number	Settingrange	Defaults	Parameter Description
L-1	0-99	6	Duration of entrance/exit opening (in seconds)
L-2	0-3	0	Turnstile working modes 0: Swipe left swipe right 1: Swipe left IR swipe right 2:Right infrared left swipe 3:Left and right infrared
L-3	0.1 - 99.9	0.2	Delayed closing time (in seconds)
L-4	0-41	1	Passing voice on the left

L-5	Right pass voice	15	0-41
L-6	Infrared superimposition time (in seconds)	3	0-30
L-7	Power failure opening direction	0	0 for: left open 1 for: right open
L-8	Alarm voice	0	0 for: trespassing please swipe card 13 for: dripping sound
L-9	Entrance/exit memory function configuration	0	0 for: without memory function 1 representative: with memory function
L-10	Infrared anti-pinch action	0	0 for: Emergency stop + door opening 1 rep: Rush stop + stay put
L-11	Number of infrared	0	0 for: 4 1 for: 6
L-12	Voice volume	15	0 min 15 max
L-13	Voice test		Press OK to exit
L-14	Aging test		Press OK to enter, press Menu to exit
L-17	Reverse gate closure options	0	0 for: no gate closure 1 for: gate closure
L-18	Two-colour light tri-colour control options	0	0 for: two-colour light 1 for: three-colour light
L-19	Can gates be opened in the passageway	0	0 represents: the channel can be swiped to open the gate 1 represents: the channel can not be swiped to open the gate
L-20	Wing gate infra-red shutter option	0	0 for: Wing gate closed after anti-pinch 1 for: Wing gate closed after the last pair of IR
L-21	Infrared anti-trailing on or off	0	0: not open 1: open (after the person enters the channel, if the first team entrance infrared and is blocked then it is considered a tailing alarm)
L-22	Does the gate close after tailgating	0	0: Alarm only after tailgating, no gate closure 1: Alarm after tailgating, followed by gate closure
L-23	Duration of constant opening signal	5	0-999
L-24	Tailgating Alarm Voice	0	0-41
L-25	Retrograde Alarm Voice	0	0-41
L-26	Stranded Alarm Voice	0	0-41
D-1	Zero setting		If the door is not aligned properly the motor swings loosely to the desired closing position after entry
D-2	Left door position setting		Enter and open the gate left then the motor releases the shaft and swings to the desired opening position
D-3	Right door position setting		Enter and open the gate right then swing the motor loose shaft to the desired opening position
D-4	Door opening and closing speed setting	3	1 Fastest 10 Slowest
D-5	Gate mode	0	0 Pendulum gate 1 Wing gate
D-6	Availability of clutch	0	0 No 1 Yes
D-7	Rebound mode	0	0: After hitting a person, it bounces back and continues to drive 1: After hitting a person, it pauses and continues to drive
D-8	Strength of confrontation	10	1-20 The higher the value the higher the counteracting power The lower the value the lower the counteracting power
D-9	Reset time	0	0-40
D-10	Main closing cushion strength	50	The higher the value from 1 to 100, the stronger the position
D-11	Host motor speed	65	The higher the value from 1 to 100, the faster the motor speed, the lower

			the value, the slower the motor speed
D-12	Buffer strength from closing doors	50	The higher the value from 1 to 100, the stronger the position
D-13	Slave machine speed	65	The higher the value from 1 to 100, the faster the motor speed, the lower the value, the slower the motor speed
D-14	Power supply power	6	1 - 10
D-15	Speed of change on power up	5	The higher the value from 1 to 10, the faster the change, the lower the value, the slower the change
D-16	Wing gate zero direction	0	0/1 If the wing gate position appears to be incorrect, set to 1
D-17	Physical anti-pinch sensitivity	75	The higher the value from 1-99 the less sensitive the physical anti-pinch is, the lower the value the more sensitive the anti-pinch is
D-18	Physical anti-pinching current time	10	The higher the value from 1-99 the less sensitive the physical anti-pinch is, the lower the value the more sensitive the anti-pinch is
D-19	Acceleration current	160	The higher the value, the faster the motor starts, the lower the value, the slower the motor starts
D-20	Acceleration current time	10	The higher the value, the faster the motor start time, the lower the value, the slower the motor start time
D-21	Clutch suction angle	15	The larger the value, the larger the suction angle, the smaller the value, the smaller the suction angle
D-22	Duty cycle for clutch adjustment	10	
D-23	Physical anti-pinch response time	0	The slower the speed, the greater the value
D-24	Plug to Zero Sensitivity	2	The larger the value, the longer the blockage, the smaller the value, the shorter the blockage
D-25	Duration of current protection	2	The higher the value the longer the protection time, the lower the value the shorter the protection time
D-26	Slave gate confrontation strength	13	1-20 The higher the value the higher the counteracting power The lower the value the lower the counteracting power
D-27	Deceleration stroke	8	The higher the value, the earlier the deceleration

Chapter 6– Trouble shooting code meanings

Display E-1 :Main Motor Hall Error:adjust L-15 to 1

Display E-2 :Slave Motor Hall Error :adjust L-16 to 1

Unmentioned errors, contact with Karsun team for technical trouble-shooting.

Chapter 7– Safety attentions

- Do not strike the product with hard objects.
- Handle carefully when using to avoid strong collision with hard objects.
- The product must not be exposed to water or corrosive liquids.
- If smoke or odor is found in the product, disconnect the power immediately.
- If the product is abnormal, please contact the dealer in time. Do not attempt to repair it by yourself. If you do not contact the dealer, handle it without permission, and the company will not be responsible for any damage.

Chapter 8 – Transportation and storage

- Handle the product with care when handling it.
- During the transportation and storage of the product, care should be taken in a dry and free of corrosive or explosive gas in the surrounding air, and measures should be taken to prevent moisture, rain, sun, and corrosion

Thank you for your support, we are very happy to be your partner and provide you with our services. If you encounter any problems during the installation, you can contact your service manager at any time. We will serve you wholeheartedly ,ENJOY!

----- KARSUN TEAM